

History of the L.F. Benton Company, Vergennes, VT

William D. Benton,
great grandson of L.F. Benton



Early Years



Leicester Felix Benton



Cecil Richardson Benton, 1899

In 1906, my great grandfather, Leicester Felix Benton (1841-1913) and his son Cecil Richardson Benton (1878 -1955), purchased the eastern portion of the falls on the Otter Creek in Vergennes, Vt., formerly the site of the Parker and Folardo window sash factory which was destroyed by fire. On that site, between 1906 - 1907, the water powered, L.F. Benton Company machine tool plant was constructed.

L.F. Benton received an honorary degree of Master of Arts from Middlebury College in 1869. He was a teacher at numerous local schools until ill health led him to resign as principal of Bristol Academy in 1881. Thereafter, he was a general agent for Massachusetts Mutual Life and he was known locally as a surveyor and mathematician.

Cecil Benton attended Middlebury College and in 1895 received a degree in mechanical engineering from Worcester Polytechnic Institute. After college, he worked for Schraeder Valve Company, American Lithograph Company and American Watch Company.

In 1900, he was hired as a draftsman and experimental engineer for Thomas Edison in Orange, NJ. He remained there until July 1903 and received a commendation from Edison. Edison noted in a letter, "Cecil Benton has been in my employ for three years and his work has been very satisfactory". C.R. Benton said of Edison: "... he was a wonderful man to work for. He was so prolific of ideas that he would outline his thoughts to his assistants and then leave them alone until they had worked out the details. My work

laboratory was concerned with the perfecting of the phonograph and the Edison storage battery”.



C.R. Benton (second row on the right) in the Edison lab with co-workers.

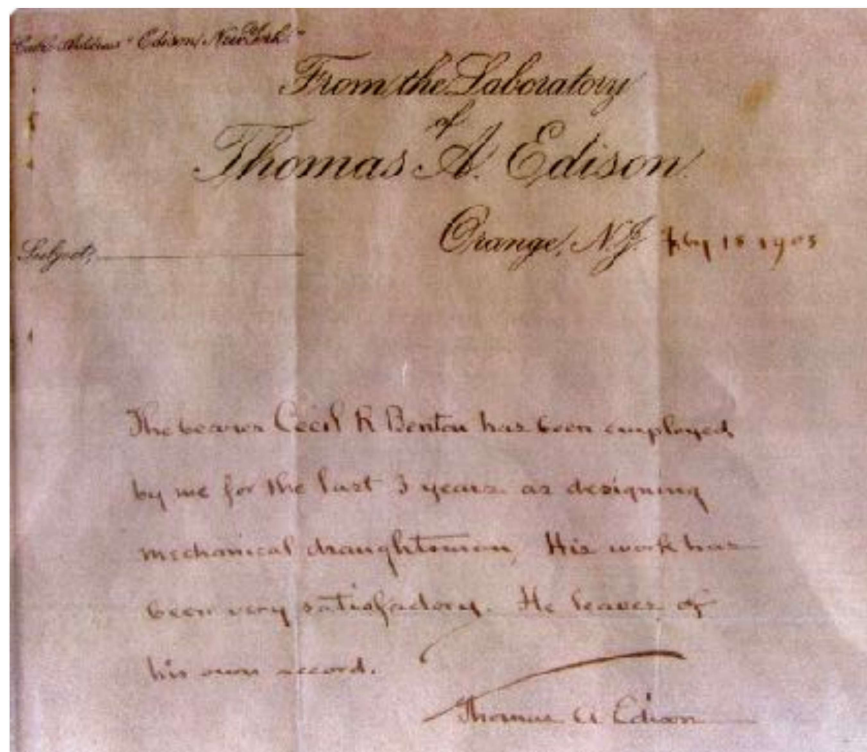

Cecil R. Benton left the Edison labs in July 1903.

Upon leaving Edison's employ, C.R. Benton returned to Vergennes to enter into a partnership with his father. After purchasing the Parker and Folardo property in 1906, L.F. Benton and C.R. Benton repaired the penstock and flume and completed a water-powered, two story, 3500 sf. factory for the manufacture of machine tool parts calling the firm, L.F. Benton Co. Inc.



L.F. Benton in flume prior to construction.

The building was constructed by local laborers and constructed of a heavy wood frame capable supporting an intricate belt and pulley system which converted water power to the machine shop floor.

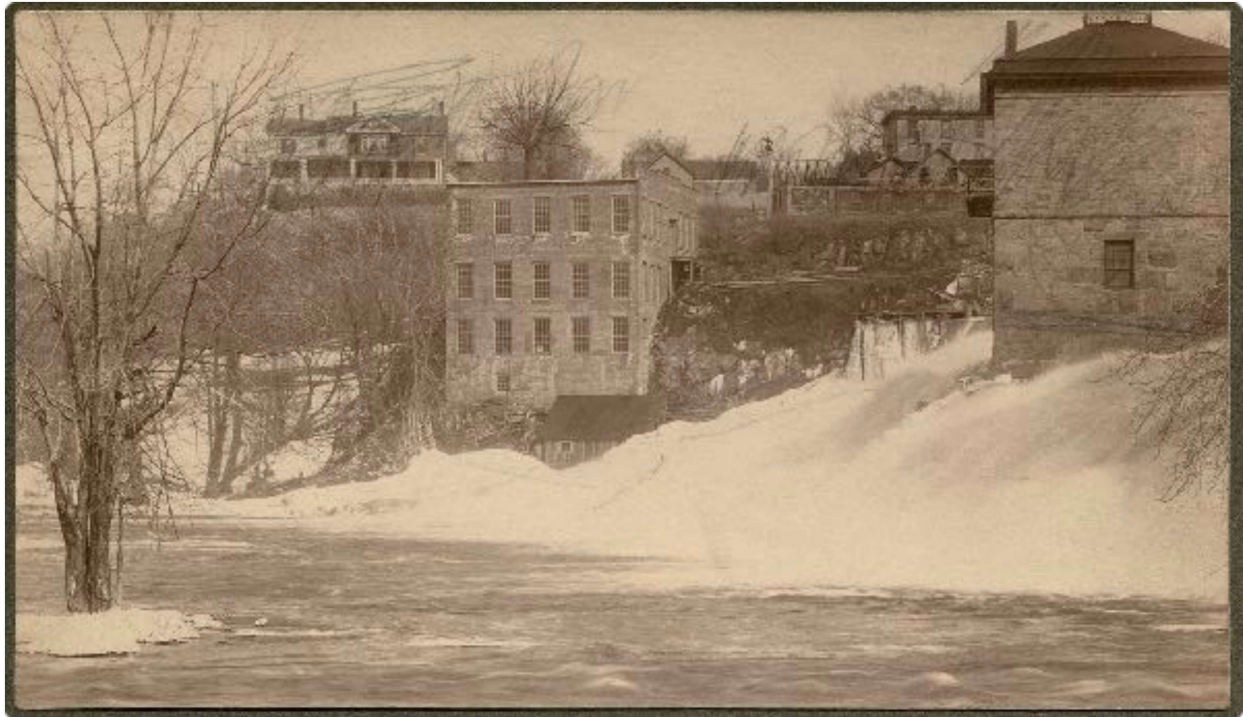

First building completed 1907.

The firm was incorporated in the State of New York and the first meeting of stockholders was held on January 15, 1907 with original stockholders L.F. Benton, Cecil R. Benton, Freeman Griswold and Charlotte E. Benton present. Each of the stockholders paid \$100.00 for one share of capital stock. Leicester F. Benton was granted an additional 596 shares as compensation for the land, building and water wheel on the east side of Otter Creek. On January 19, 1907, the stockholders held a meeting and agreed to purchase four Pratt and Whitney turret lathes, one Cincinnati Universal grinder, one Hendy milling machine and one Cochran-Bly filing machine. The L.F. Benton Company began manufacturing in 1907. Shortly thereafter, they began manufacturing magnetos and spark plug parts for several national companies including Splitdorf, Moshler and Bemford.

On March 30, 1907, the stockholders agreed to purchase from R.L. Taft his Stanley Auto runabout Model E.X. #2086 for ten shares of treasury stock.

The Benton Spark Plug

Beginning in 1912, the company began manufacturing and distributing “The Benton” spark plug, a mica plug that performed well in the new invention, the automobile. At this time, a small brick addition was added to the south end of the plant facing Main Street and the former small office building that was part of the Parker and Folardo property was moved back to the site. Production ran as high as 3000 spark plug sets per day. According to account books, annual wages at the time were \$2,250 for L.F. Benton and \$3,480 for C.R. Benton.

At a stockholder meeting on June 31, 1913 a resolution was presented and unanimously passed deeply lamenting the sudden and unexpected death of firm President L.F. Benton. C.R. Benton was subsequently elected President of the L.F. Benton Co., Inc.

One year later, in 1914, the firm developed an 18-millimeter spark plug that was standard equipment on Indian Motorcycles and sold throughout the U.S., Australia, New Zealand, South Africa, India, Spain and Holland. A photograph of an Indian Motorcycle dealer in Johannesburg South Africa clearly shows an advertisement for “The Benton” spark plug. Also in 1914, a contract for spark plugs with the manufacturer of Franklin Motor car was signed offering greater sales.



Benton Spark Plug advertisement Johannesburg, S.A.

An inventory of the furniture and fixtures in the L.F. Benton Co. office building taken January 1, 1915 includes a Remington typewriter valued at an astounding \$110.00 and a printing press valued at \$222.30. Plant machinery was valued at \$15,700, small tools \$2,900 and the real estate including the addition to the original building \$44,501.16.

The L.F. Benton Company was a contributor to the World War I effort. Benton spark plugs were supplied to the Navy for gasoline engines in submarines and other marine engines.

L. F. BENTON CO.
BENTON SPARK PLUGS
SCREW MACHINE PRODUCTS

VERGENNES, VT. November 20, 1920.

United States Navy Department,
Washington, D. C.

DATE	ORDER NO.	QUANTITY	DESCRIPTION	UNIT PRICE	TOTAL	REMARKS
1917.						
May 23.		350	3/8 in. Pipe D. N. Plugs	@ .23	\$ 80.50	
		400	7/8-18 " " " "	@ .23	100.00	
			(Shipped to Philadelphia.)			\$ 180.50
May 24		1000	3/8 in. Pipe D. N. Plugs	@ .23	230.00	(Shipped to Brooklyn, N.Y.)
May 24		2000	3/8 in. Pipe D. N. Plugs	@ .23	460.00	(Shipped to Brooklyn.)
May 25		1000	3/8 in. Pipe D. N. Plugs	@ .23	230.00	(To Brooklyn.)
June 16		1000	3/8 in. Pipe D. N. Plugs	@ .23	230.00	(To Philadelphia.)
June 16		500	3/8 in. Pipe D. N. Plugs	@ .23	115.00	(To Philadelphia.)
June 19		300	7/8-18 Pipe Plugs	@ .23	75.00	(To Boston.)
July 15		1000	3/8 in. Pipe Plugs	@ .23	230.00	(To Philadelphia.)
July 11		1000	3/8 in. Pipe Plugs	@ .23	230.00	(To Brooklyn.)
July 13		1000	3/8 in. Pipe Plugs	@ .23	230.00	(To New York.)
July 14		850	3/8 in. Pipe Plugs	@ .23	195.50	(To Philadelphia.)
July 31		200	7/8-18 Pipe Plugs	@ .23	50.00	(To Boston.)
July 31		300	7/8-18 Pipe Plugs	@ .23	75.00	
31		100	7/8-18 " " "	@ .23	25.00	
31		500	3/8 in. " " "	@ .23	75.00	(To Portsmouth, N. H.)
July 31		400	7/8-18 Pipe Plugs	@ .23	100.00	(To Philadelphia.)
Aug. 6		1000	3/8 in. Pipe Plugs	@ .23	260.00	(To Mare Island.)
Aug. 22		1000	3/8 in. Pipe Plugs	@ .23	230.00	
Aug. 22		1000	3/8 in. Pipe Plugs	@ .23	230.00	(To Boston.)
Aug. 23		1000	3/8 in. Pipe Plugs	@ .23	230.00	(To Philadelphia.)
Sept. 4		1000	3/8 in. Pipe Plugs	@ .23	230.00	(To Brooklyn.)
Sept. 5		1500	3/8 in. Pipe Plugs	@ .23	390.00	

U.S. Navy order.

A list of publications in which the L.F. Benton Co. was advertising in 1917 includes: multiple editions of the American Exporter, Automobile Dealer and Repairer, Motorcycle Illustrated, Chilton Directory and Chilton Trade Journal.

Chilton Directory

Chilton Directory January

THE BENTON
"THE CASE-HARDENED PLUG"

Unbreakable sound
metal insulator quickly
cleaned by opening
metal-to-metal joint
and scraping or wash-
ing rods. Joint al-
ways gas tight. No
deterioration from
clearing. Case-hard-
ened wrench and
thread surfaces. Ser-
vice guaranteed.

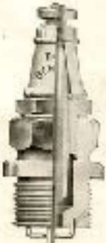

Price \$1.00
Trade for one liberal
sample of spark plug and
a copy of booklet.

L. F. BENTON CO.
300 Main St. VERGENNES, VT.

Chilton Directory Apr.

THE BENTON
"THE CASE-HARDENED PLUG"

Unbreakable sound
metal insulator quickly
cleaned by opening
metal-to-metal joint
and scraping or wash-
ing rods. Joint al-
ways gas tight. No
deterioration from
clearing. Case-hard-
ened wrench and
thread surfaces. Ser-
vice guaranteed.

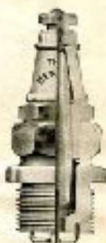

Price \$1.00
Trade for one liberal
sample of spark plug and
a copy of booklet.

L. F. BENTON CO.
300 Main St. VERGENNES, VT.

Chilton Directory July

THE BENTON
"THE CASE-HARDENED PLUG"

Unbreakable sound
metal insulator quickly
cleaned by opening
metal-to-metal joint
and scraping or wash-
ing rods. Joint al-
ways gas tight. No
deterioration from
clearing. Case-hard-
ened wrench and
thread surfaces. Ser-
vice guaranteed.

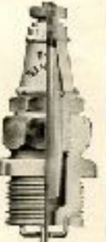

Price \$1.00
Trade for one liberal
sample of spark plug and
a copy of booklet.

L. F. BENTON CO.
310 Main St. VERGENNES, VT.

Chilton Directory Dec.

THE BENTON
"THE CASE-HARDENED PLUG"

Unbreakable sound
metal insulator quickly
cleaned by opening
metal-to-metal joint
and scraping or wash-
ing rods. Joint al-
ways gas tight. No
deterioration from
clearing. Case-hard-
ened wrench and
thread surfaces. Ser-
vice guaranteed.



Price \$1.00
Trade for one liberal
sample of spark plug and
a copy of booklet.

L. F. BENTON CO.
310 Main St. VERGENNES, VT.

Benton Spark Plug ads for Chilton Directory.

In 1918, C.R. Benton, as President of the L.F. Benton Co., entered into an agreement with the City of Vergennes to construct a new concrete dam on the east channel to stop leakage from the aging wooden dam. The completion of the dam greatly increased the efficiency of the water power and led to power generation on the site. Soon thereafter, electricity generated at the Vergennes Falls powered Burlington street cars.

After World War I, the L.F. Benton Company concentrated on low priced spark plugs for the replacement automobile plug business. The "Benton" was sold throughout the country at Montgomery Ward, W.T. Grant and S.H. Kress. A dealer list compiled by L.F. Benton Company "Screw Machine Products" in 1923 lists a total of 303 jobbers and 13,675 dealers nationwide. Literature from 1921 states: "The Benton is a hand made plug of the highest quality... The distinctive outstanding features are its UNBREAKABLE, HAND WOUND INDIA RUBY MICA INSULATOR and its simple TWO UNIT CONSTRUCTION".



The Benton Spark Plug advertising .

Benton dealers were enticed by the quality of the specialized plug and the profit percentage of 100% that they were offered. Dealer prices were \$0.50 per plug with a retail price of \$1.00. Dealer literature continues: "Equipping a man's car with good Benton Spark Plugs is a sure way to win his favor and steady respect for the judgment of the dealer who recommended them to him". In 1929, C.R. Benton's salary as general manager was \$10,000 a year.

In the 1930's, a decline in the automobile business and advances in aviation opened up a new transportation frontier and business for the L.F. Benton Co. In 1938, C.R. Benton was issued U.S. Patent 2139793 for the "A" electrode plug, a short reach mica plug for aircraft. In 1940, he was issued U.S. Patent 2206073 for a basic method of assembly using a tapered winding machine. An additional patent for an aircraft spark plug was awarded in 1944.

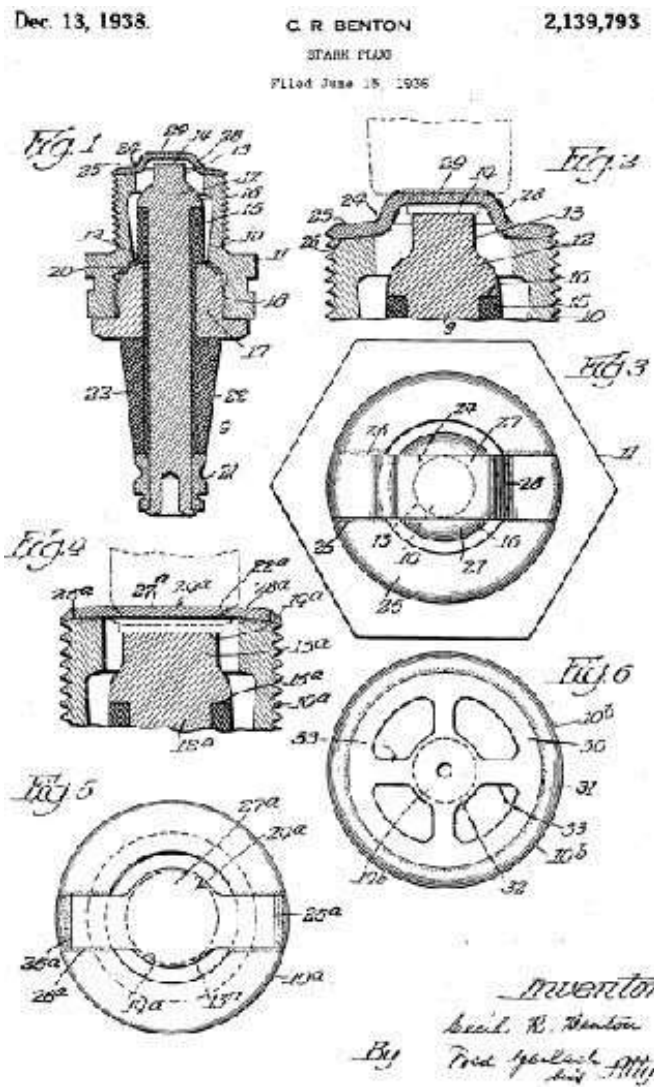

C. R. Benton Plug Patent, awarded 1938.

New Partnerships



Simmonds-Benton
Aircraft power plug.

In the late 1930's, C.R. Benton's son, Malcolm Benton was charged with selling "Benton" aviation spark plugs. On business in New York, he met William Enyart, the president of Simmonds Aerocessories Ltd. in America.

Simmonds was founded by Sir Oliver Simmonds in 1931 in Britain and was involved with the licensing and distribution of aircraft push-pull controls and float fuel management systems. At Mal Benton's suggestion, in 1940, Simmonds took over marketing and distribution of the mica Benton aviation plugs.

Simmonds utilized C.R. Benton's engineering expertise, the 1940 ledger noted that Simmonds paid the L.F. Benton Co. \$21,007 for the development of a new aviation spark plug.

On January 1, 1941, the L.F. Benton Co. entered into a 25-year lease agreement with Green Mountain Power for the water rights, structures and equipment, dam and water wheel for power generation purposes.

In April 1941, Simmonds purchased the Benton product line and the spark plugs were manufactured under the Simmonds-Benton name. C.R. Benton became a consulting engineer and M.I. Benton was hired as plant manager in Vergennes. Later in 1941, Simmonds purchased the L.F. Benton Company outright, it employed 33 people and grossed under \$200,000 in sales.

With the advent of World War II, a large addition was added to the south side of the existing building in 1941. A 1941 service manual shows an architectural rendering of the addition that almost doubled the size of the original plant. According to the 1941 L.F. Benton Co. account ledger, the plant addition cost \$18,068. Soon, the Vergennes plant

was manufacturing spark plugs, bomb clips and push-pull controls night and day. In 1942, the company was named the Vergennes Division of Simmonds Aerocessories, Inc.



1942 addition to Simmonds-Benton Plant.

Soon an additional plant was rented on the opposite side of the Otter Creek Falls in 1944. At the end of World War II, there were 250 employees at the manufacturing plants in Vergennes. In the ten-day period following the conclusion of World War II, a backlog of several million dollars shrank to \$60,000. Mal Benton recalled that shortly after the war "Two or three times we had to borrow to meet payroll". Shortly thereafter, Oliver Simmonds sent a fuel gauging product for manufacture. This not only marked the entry into the fuel management business but represented an entry into electro-mechanical assembly.

In 1952, the firm constructed a new, 40,000 sf. manufacturing facility on Panton Road in the City of Vergennes for the development and manufacture of aerospace fuel measurement and management systems.

The building was to be the first of many that would ultimately include production, engineering and administrative offices. The plant was designed by Freeman French and Freeman of Burlington and built by William Adams and Son of Burlington.



In 1960, the firm Simmonds Aeroaccessories was renamed Simmonds Precision Products Inc. and became a public company. In 1964, an additional 20,000 sf. addition was completed and in 1969 a 12,500 sf. addition was built. The company entered the speed and torque sensor market and in 1964 won a contract for the Apollo space program propellant gauging system. In the 1970's, opportunities brought contracts for the U.S. Air Force F-15, F-16 and B-1 programs and the Lockheed L-1011 and Boeing 727-737 aircraft. At this time, there was a Simmonds Precision Product on more than 50,000 commercial and military aircraft.

In 1983, Simmonds was purchased by Hercules Incorporated. In 1990, the former Simmonds Precision business units were purchased by Goodrich Corporation and in 2016, the instrument systems division was purchased by United Technologies Corporation. The firm still operates today as Collins Aerospace division of UTC at the Panton Road location in Vergennes and employs approximately 900 people.

Today

The original plant and office at 300 Main Street in Vergennes, VT remain in the Benton Family today. In 1991, the author moved his business, W.D. Benton Inc., Appraisers into 302 Main Street, the Italianate office building that was saved from the Parker and Folardo fire. In 2019, the business was relocated into the front of 300 Main Street and the BENTON logo was re-instituted for the appraisal business. William Benton now uses the same office his father did in 1942.

Sources:

L.F. Benton Obituary
C.R. Benton Obituary
Burlington Free Press articles on C.R. Benton
L.F. Benton Co. Advertising Catalog
L.F. Benton Co. Dealer Promotion Diary
L.F. Benton Co. List of dealers and jobbers 1923
L.F. Benton Co. financial ledgers 1940 - 1942
Simmonds Precision Aircraft Systems 50th Year Anniversary Publication
Simmonds Products Newsletter Vol 1 No. 5 January 21, 1944
Simmonds - Benton Aircraft Power Plug Service Manual
Hugh Henry: History of the 300 Main Street wheelhouse
Wikipedia: Oliver Simmonds Life
U.S. Patent Office
Correspondence with the Laboratory of Thomas A. Edison

Credits:

Photographs of the construction of 300 Main Street and L.F. Benton Co. products in the Collection of William and Kristin Benton.

Special thanks to Catherine Brooks for helping with editing, layout and all things necessary to put this document together.